

# Ref. 18556 - AW .308 Gas Operated Sniper

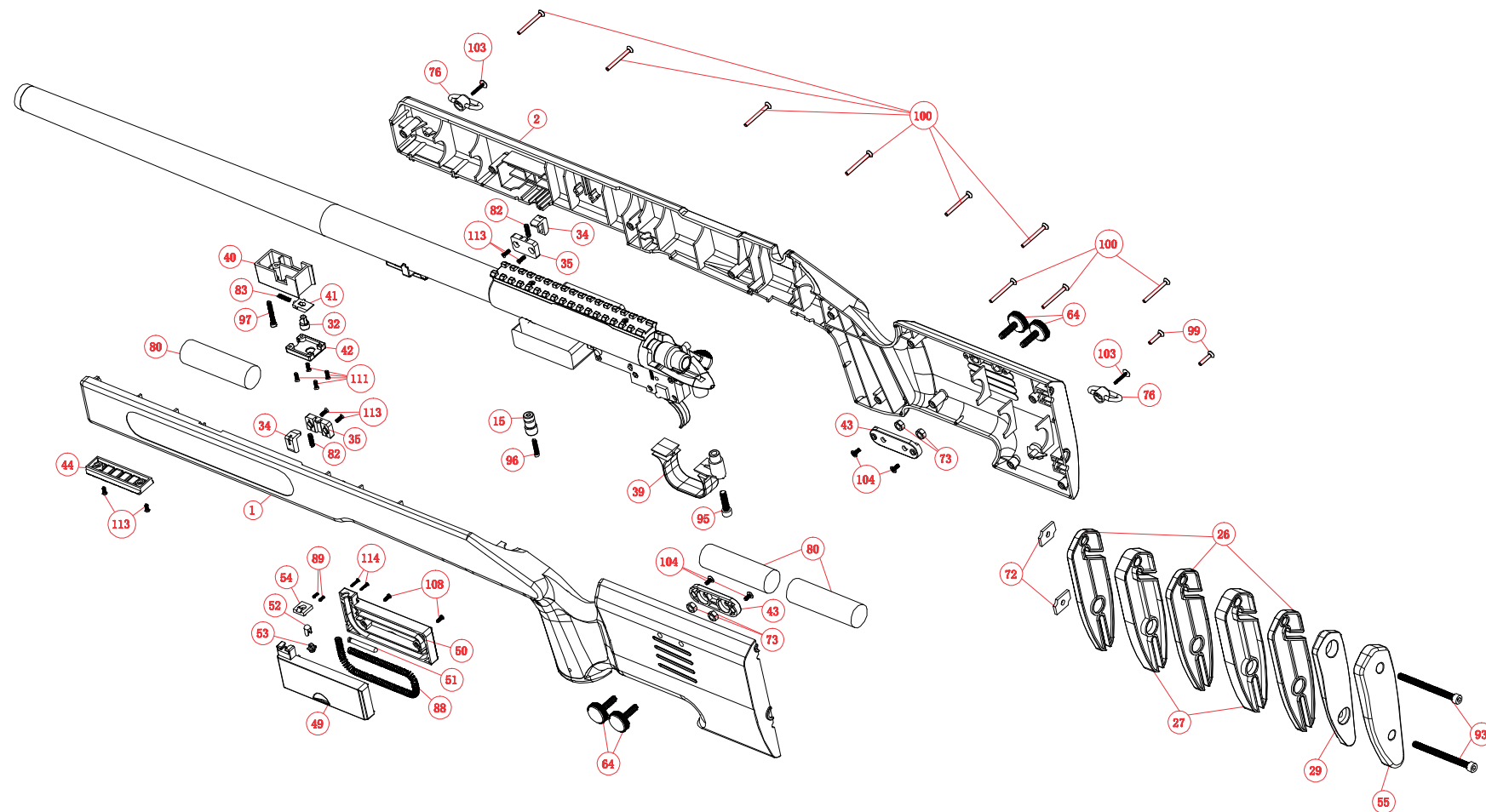

# Ref. 18556 - AW .308 Gas Operated Sniper

